

KLEŠTINOVÉ DRŽÁKY

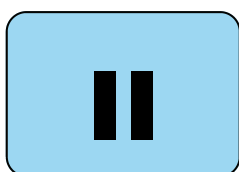

NTA s.r.o.
Komenského 365
763 16 Fryšták
www.nta.cz ntaoffice@nta.cz
Tel.: 571 117 847 Fax: 571 118 402



KLEŠTINOVÉ DRŽÁKY S MATICÍ MINI OBOUSTRANNÉ

DIN 6499

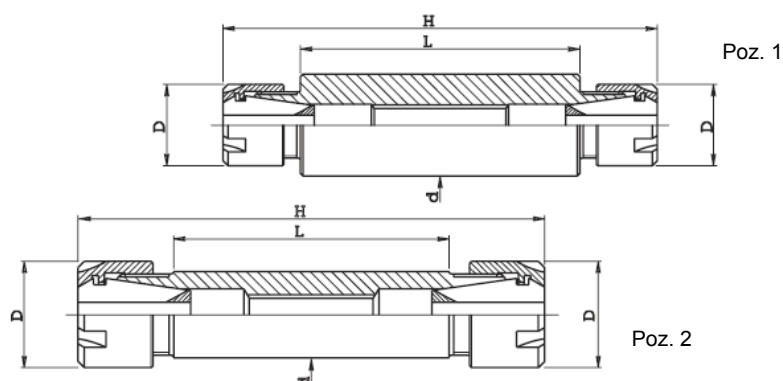

KOD	d	L	H	D	Kleština	Poz.
159.716 040	16	40	71	16	ERC 11	1
159.719 042	19.05	42	70	16	ERC 11	1
159.719 052	19.05	52	80	16	ERC 11	1
159.719 062	19.05	62	90	16	ERC 11	1
159.719 092	19.05	92	120	16	ERC 11	1
159.719 102	19.05	102	130	16	ERC 11	1
159.719 112	19.05	112	140	16	ERC 11	1
159.720 042	20	42	70	16	ERC 11	1
159.720 052	20	52	80	16	ERC 11	1
159.720 062	20	62	90	16	ERC 11	1

ERC 11

KOD	d	L	H	D	Kleština	Poz.
159.019 037	19.05	37	80	22	ERC 16	2
159.019 057	19.05	57	100	22	ERC 16	2
159.019 067	19.05	67	110	22	ERC 16	2
159.020 037	20	37	80	22	ERC 16	2
159.020 057	20	57	100	22	ERC 16	2
159.020 067	20	67	110	22	ERC 16	2
159.020 122	20	122	165	22	ERC 16	2
159.022 027	22	27	70	22	ERC 16	1
159.022 047	22	47	90	22	ERC 16	1
159.022 067	22	67	110	22	ERC 16	1
159.022 102	22	102	145	22	ERC 16	1
159.022 122	22	122	165	22	ERC 16	1
159.025 027	25	27	70	22	ERC 16	1
159.025 047	25	47	90	22	ERC 16	1
159.025 067	25	67	110	22	ERC 16	1
159.026 027	25.40	27	70	22	ERC 16	1
159.026 047	25.40	47	90	22	ERC 16	1
159.026 067	25.40	67	110	22	ERC 16	1

ERC 16

KOD	d	L	H	D	Kleština	Poz.
159.125 082	25	82	130	28	ERC 20	2
159.126 082	25.40	82	130	28	ERC 20	2
159.132 057	32	57	105	28	ERC 20	1
159.132 082	32	82	130	28	ERC 20	1

ERC 20

KLEŠTINOVÉ DRŽÁKY S MATICÍ MINI OBOUSTRANNÉ

DIN 6499

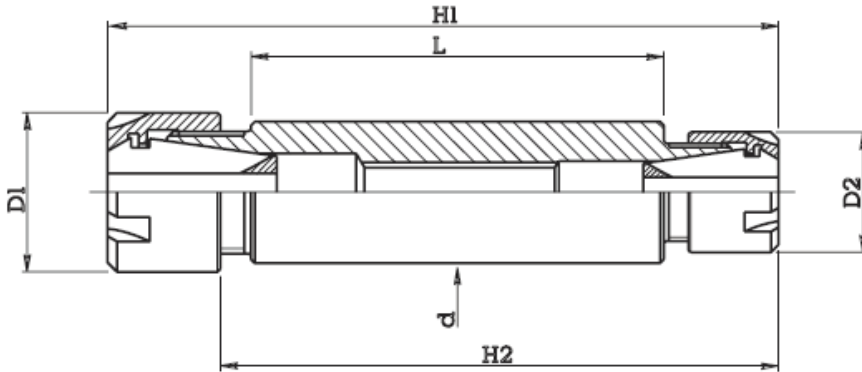

KOD	d	L	H1	H2	D1	Kleština 1	D2	Kleština 2
158.019 050	19.05	50	85	68	22	ERC 16	16	ERC 11
158.020 050	20	50	85	68	22	ERC 16	16	ERC 11

ERC 11

KOD	d	L	H1	H2	D1	Kleština 1	D2	Kleština 2
158.119 050	19.05	50	91	72	28	ERC 20	16	ERC 11
158.120 050	20	50	91	72	28	ERC 20	16	ERC 11

ERC 11

KOD	d	L	H1	H2	D1	Kleština 1	D2	Kleština 2
158.122 045	22	45	90	71	28	ERC 20	22	ERC 16
158.122 060	22	60	105	86	28	ERC 20	22	ERC 16
158.125 045	25	45	90	71	28	ERC 20	22	ERC 16
158.125 060	25	60	105	86	28	ERC 20	22	ERC 16

ERC 16

KOD	d	L	H1	H2	D1	Kleština 1	D2	Kleština 2
158.225 045	25	45	91	71	35	ERC 25	22	ERC 16
158.225 060	25	60	106	86	35	ERC 25	22	ERC 16

ERC 16

KOD	d	L	H1	H2	D1	Kleština 1	D2	Kleština 2
158.232 060	32	60	108	88	35	ERC 25	28	ERC 20

ERC 20

KLEŠTINOVÉ DRŽÁKY S MATICÍ MINI

DIN 6499

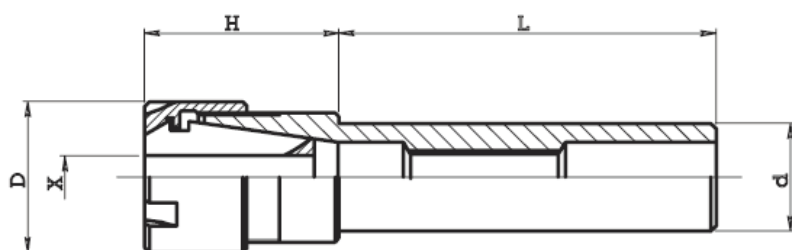

KOD	d	L	H	D	X	Kleština	Kod kleštiny	Kod matice	Kod klíče
162.805 045	5	45	22	12	0.5 - 5	ERC 8	050.008	052.108	053.108
162.806 045	6	45	22	12	0.5 - 5	ERC 8	050.008	052.108	053.108
162.808 055	8	55	22	12	0.5 - 5	ERC 8	050.008	052.108	053.108
162.808 080	8	80	22	12	0.5 - 5	ERC 8	050.008	052.108	053.108
162.810 055	10	55	20	12	0.5 - 5	ERC 8	050.008	052.108	053.108
162.810 080	10	80	20	12	0.5 - 5	ERC 8	050.008	052.108	053.108
162.812 100	12	100	20	12	0.5 - 5	ERC 8	050.008	052.108	053.108
162.813 100	12.7	100	20	12	0.5 - 5	ERC 8	050.008	052.108	053.108

ERC 8

KOD	d	L	H	D	X	Kleština	Kod kleštiny	Kod matice	Kod klíče
162.706 045	6	45	26	16	0.5 - 7	ERC 11	050.011	052.111	053.111
162.707 045	7	45	26	16	0.5 - 7	ERC 11	050.011	052.111	053.111
162.708 055	8	55	26	16	0.5 - 7	ERC 11	050.011	052.111	053.111
162.708 100	8	100	26	16	0.5 - 7	ERC 11	050.011	052.111	053.111
162.710 055	10	55	26	16	0.5 - 7	ERC 11	050.011	052.111	053.111
162.710 100	10	100	26	16	0.5 - 7	ERC 11	050.011	052.111	053.111
162.712 070	12	70	26	16	0.5 - 7	ERC 11	050.011	052.111	053.111
162.712 100	12	100	26	16	0.5 - 7	ERC 11	050.011	052.111	053.111
161.715 100	15.875	100	20	16	0.5 - 7	ERC 11	050.011	052.111	053.111
161.716 040	16	40	20	16	0.5 - 7	ERC 11	050.011	052.111	053.111
161.716 100	16	100	20	16	0.5 - 7	ERC 11	050.011	052.111	053.111
161.716 160	16	160	20	16	0.5 - 7	ERC 11	050.011	052.111	053.111
161.719 100	19.05	100	20	16	0.5 - 7	ERC 11	050.011	052.111	053.111
161.720 100	20	100	20	16	0.5 - 7	ERC 11	050.011	052.111	053.111
161.720 160	20	160	20	16	0.5 - 7	ERC 11	050.011	052.111	053.111
161.722 120	22	120	20	16	0.5 - 7	ERC 11	050.011	052.111	053.111
161.726 120	25.40	120	20	16	0.5 - 7	ERC 11	050.011	052.111	053.111

ERC 11

KLEŠTINOVÉ DRŽÁKY S MATICÍ MINI

DIN 6499

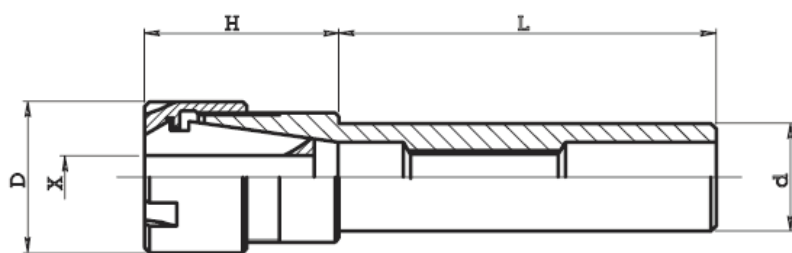

KOD	d	L	H	D	X	Kleština	Kod kleštiny	Kod matice	Kod klíče
162.008 055	8	55	36	22	0.5 - 10	ERC 16	050.016	052.116	053.116
162.008 100	8	100	36	22	0.5 - 10	ERC 16	050.016	052.116	053.116
162.010 060	10	60	36	22	0.5 - 10	ERC 16	050.016	052.116	053.116
162.012 080	12	80	36	22	0.5 - 10	ERC 16	050.016	052.116	053.116
162.014 080	14	80	36	22	0.5 - 10	ERC 16	050.016	052.116	053.116
161.015 034	15.875	34	25	22	0.5 - 10	ERC 16	050.016	052.116	053.116
161.015 060	15.875	60	40	22	0.5 - 10	ERC 16	050.016	052.116	053.116
161.016 034	16	34	25	22	0.5 - 10	ERC 16	050.016	052.116	053.116
161.016 060	16	60	40	22	0.5 - 10	ERC 16	050.016	052.116	053.116
161.016 100	16	100	40	22	0.5 - 10	ERC 16	050.016	052.116	053.116
161.016 160	16	160	40	22	0.5 - 10	ERC 16	050.016	052.116	053.116
161.019 060	19.05	60	24	22	0.5 - 10	ERC 16	050.016	052.116	053.116
161.019 070	19.05	70	24	22	0.5 - 10	ERC 16	050.016	052.116	053.116
161.019 100	19.05	100	24	22	0.5 - 10	ERC 16	050.016	052.116	053.116
161.019 130	19.05	130	24	22	0.5 - 10	ERC 16	050.016	052.116	053.116
161.020 060	20	60	24	22	0.5 - 10	ERC 16	050.016	052.116	053.116
161.020 100	20	100	24	22	0.5 - 10	ERC 16	050.016	052.116	053.116
161.020 130	20	130	24	22	0.5 - 10	ERC 16	050.016	052.116	053.116
161.022 125	22	125	24	22	0.5 - 10	ERC 16	050.016	052.116	053.116
161.025 060	25	60	24	22	0.5 - 10	ERC 16	050.016	052.116	053.116
161.025 100	25	100	24	22	0.5 - 10	ERC 16	050.016	052.116	053.116
161.025 130	25	130	24	22	0.5 - 10	ERC 16	050.016	052.116	053.116
161.025 160	25	160	24	22	0.5 - 10	ERC 16	050.016	052.116	053.116
161.026 100	25.40	100	24	22	0.5 - 10	ERC 16	050.016	052.116	053.116

ERC 16

KLEŠTINOVÉ DRŽÁKY S MATICÍ MINI

DIN 6499

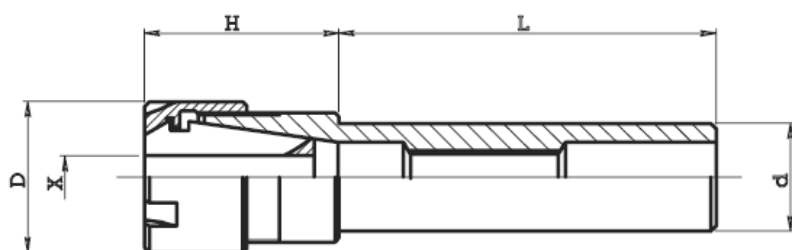

KOD	d	L	H	D	X	Kleština	Kod kleštiny	Kod matice	Kod klíče
161.116 055	16	55	40	28	0.5 - 13	ERC 20	050.020	052.120	053.120
161.116 100	16	100	40	28	0.5 - 13	ERC 20	050.020	052.120	053.120
161.119 046	19.05	46	36	28	0.5 - 13	ERC 20	050.020	052.120	053.120
161.119 100	19.05	100	36	28	0.5 - 13	ERC 20	050.020	052.120	053.120
161.119 160	19.05	160	36	28	0.5 - 13	ERC 20	050.020	052.120	053.120
161.120 046	20	46	36	28	0.5 - 13	ERC 20	050.020	052.120	053.120
161.120 100	20	100	36	28	0.5 - 13	ERC 20	050.020	052.120	053.120
161.120 160	20	160	36	28	0.5 - 13	ERC 20	050.020	052.120	053.120
161.122 080	22	80	32	28	0.5 - 13	ERC 20	050.020	052.120	053.120
161.125 070	25	70	26	28	0.5 - 13	ERC 20	050.020	052.120	053.120
161.125 100	25	100	26	28	0.5 - 13	ERC 20	050.020	052.120	053.120
161.125 130	25	130	26	28	0.5 - 13	ERC 20	050.020	052.120	053.120
161.125 160	25	160	26	28	0.5 - 13	ERC 20	050.020	052.120	053.120
161.126 070	25.40	70	26	28	0.5 - 13	ERC 20	050.020	052.120	053.120
161.126 100	25.40	100	26	28	0.5 - 13	ERC 20	050.020	052.120	053.120
161.126 130	25.40	130	26	28	0.5 - 13	ERC 20	050.020	052.120	053.120
161.126 160	25.40	160	26	28	0.5 - 13	ERC 20	050.020	052.120	053.120
161.132 095	32	95	26	28	0.5 - 13	ERC 20	050.020	052.120	053.120

ERC 20

KLEŠTINOVÉ DRŽÁKY S MATICÍ MINI

DIN 6499

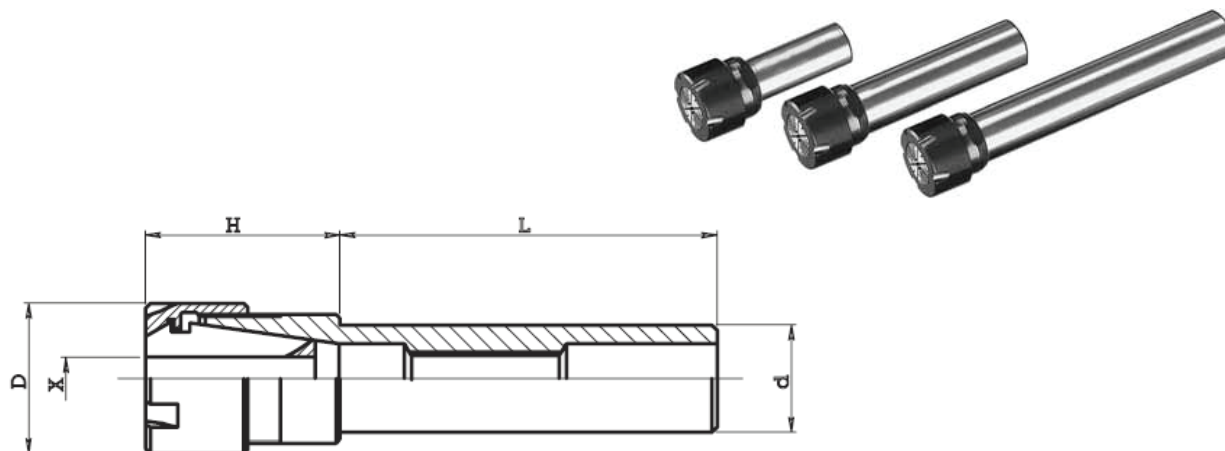

KOD	d	L	H	D	X	Kleština	Kod kleštiny	Kod matice	Kod klíče
161.219 046	19.05	46	46	35	0.5 - 16	ERC 25	050.025	052.125	053.125
161.219 100	19.05	100	46	35	0.5 - 16	ERC 25	050.025	052.125	053.125
161.220 046	20	46	46	35	0.5 - 16	ERC 25	050.025	052.125	053.125
161.220 060	20	60	46	35	0.5 - 16	ERC 25	050.025	052.125	053.125
161.220 100	20	100	46	35	0.5 - 16	ERC 25	050.025	052.125	053.125
161.220 130	20	130	46	35	0.5 - 16	ERC 25	050.025	052.125	053.125
161.220 160	20	160	46	35	0.5 - 16	ERC 25	050.025	052.125	053.125
161.222 080	22	80	46	35	0.5 - 16	ERC 25	050.025	052.125	053.125
161.225 046	25	46	32	35	0.5 - 16	ERC 25	050.025	052.125	053.125
161.225 070	25	70	32	35	0.5 - 16	ERC 25	050.025	052.125	053.125
161.225 100	25	100	32	35	0.5 - 16	ERC 25	050.025	052.125	053.125
161.225 160	25	160	32	35	0.5 - 16	ERC 25	050.025	052.125	053.125
161.226 046	25.40	46	32	35	0.5 - 16	ERC 25	050.025	052.125	053.125
161.226 070	25.40	70	32	35	0.5 - 16	ERC 25	050.025	052.125	053.125
161.226 100	25.40	100	32	35	0.5 - 16	ERC 25	050.025	052.125	053.125
161.240 100	40	100	27	35	0.5 - 16	ERC 25	050.025	052.125	053.125
161.240 120	40	120	27	35	0.5 - 16	ERC 25	050.025	052.125	053.125

ERC 25

KLEŠTINOVÉ DRŽÁKY S ŠESTIHRANNOU MATICÍ

DIN 6499

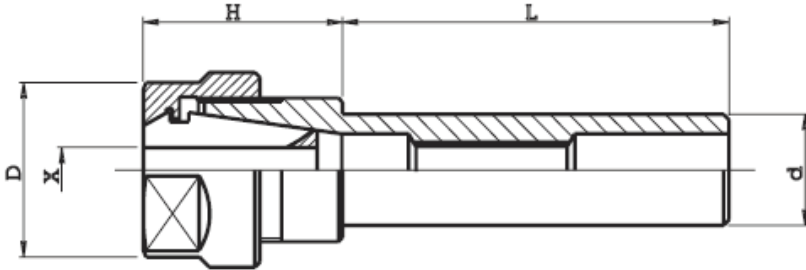

KOD	d	L	H	D	X	Kleština	Kod kleštiny	Kod matice	Kod klíče
160.015 034	15.875	34	28	28	0.5 - 10	ERC 16	050.016	052.216	053.216
160.015 060	15.875	60	30	28	0.5 - 10	ERC 16	050.016	052.216	053.216
160.016 034	16	34	28	28	0.5 - 10	ERC 16	050.016	052.216	053.216
160.016 060	16	60	30	28	0.5 - 10	ERC 16	050.016	052.216	053.216
160.016 100	16	100	30	28	0.5 - 10	ERC 16	050.016	052.216	053.216
160.016 160	16	160	30	28	0.5 - 10	ERC 16	050.016	052.216	053.216
160.019 046	19.05	46	26	28	0.5 - 10	ERC 16	050.016	052.216	053.216
160.019 100	19.05	100	26	28	0.5 - 10	ERC 16	050.016	052.216	053.216
160.020 046	20	46	26	28	0.5 - 10	ERC 16	050.016	052.216	053.216
160.020 100	20	100	26	28	0.5 - 10	ERC 16	050.016	052.216	053.216
160.020 160	20	160	26	28	0.5 - 10	ERC 16	050.016	052.216	053.216
160.022 046	22	46	26	28	0.5 - 10	ERC 16	050.016	052.216	053.216
160.022 080	22	80	26	28	0.5 - 10	ERC 16	050.016	052.216	053.216
160.022 100	22	100	26	28	0.5 - 10	ERC 16	050.016	052.216	053.216
160.025 070	25	70	24	28	0.5 - 10	ERC 16	050.016	052.216	053.216
160.025 160	25	160	24	28	0.5 - 10	ERC 16	050.016	052.216	053.216
160.026 070	25.40	70	24	28	0.5 - 10	ERC 16	050.016	052.216	053.216
160.032 100	32	100	24	28	0.5 - 10	ERC 16	050.016	052.216	053.216

ERC 16

KLEŠTINOVÉ DRŽÁKY S ŠESTIHRANNOU MATICÍ

DIN 6499

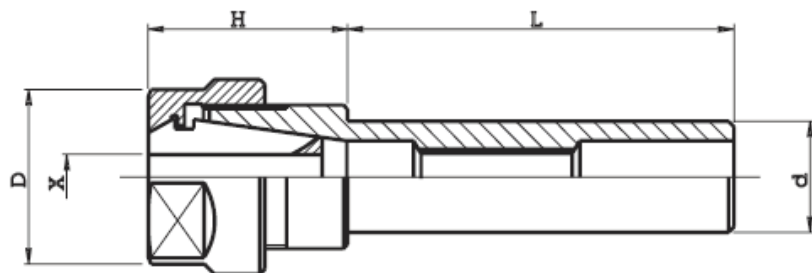

KOD	d	L	H	D	X	Kleština	Kod kleštiny	Kod matice	Kod klíče
160.119 046	19.05	46	36	34	0.5 - 13	ERC 20	050.020	052.220	053.220
160.119 100	19.05	100	36	34	0.5 - 13	ERC 20	050.020	052.220	053.220
160.120 046	20	46	36	34	0.5 - 13	ERC 20	050.020	052.220	053.220
160.120 070	20	70	36	34	0.5 - 13	ERC 20	050.020	052.220	053.220
160.120 100	20	100	36	34	0.5 - 13	ERC 20	050.020	052.220	053.220
160.122 046	22	46	26	34	0.5 - 13	ERC 20	050.020	052.220	053.220
160.122 080	22	80	26	34	0.5 - 13	ERC 20	050.020	052.220	053.220
160.125 060	25	60	26	34	0.5 - 13	ERC 20	050.020	052.220	053.220
160.125 080	25	80	26	34	0.5 - 13	ERC 20	050.020	052.220	053.220
160.126 060	25.40	60	26	34	0.5 - 13	ERC 20	050.020	052.220	053.220
160.126 080	25.40	80	26	34	0.5 - 13	ERC 20	050.020	052.220	053.220
160.130 155	30	155	26	34	0.5 - 13	ERC 20	050.020	052.220	053.220
160.132 105	32	105	26	34	0.5 - 13	ERC 20	050.020	052.220	053.220

ERC 20

KLEŠTINOVÉ DRŽÁKY S MATICÍ STANDARD

DIN 6499

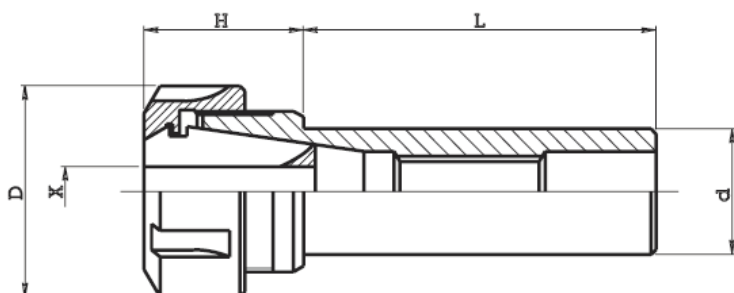

KOD	d	L	H	D	X	Kleština	Kod kleštiny	Kod matice	Kod klíče
160.219 046	19.05	46	46	42	0.5 - 16	ERC 25	050.025	052.325	053.325
160.219 100	19.05	100	46	42	0.5 - 16	ERC 25	050.025	052.325	053.325
160.220 046	20	46	46	42	0.5 - 16	ERC 25	050.025	052.325	053.325
160.220 100	20	100	46	42	0.5 - 16	ERC 25	050.025	052.325	053.325
160.222 046	22	46	46	42	0.5 - 16	ERC 25	050.025	052.325	053.325
160.222 100	22	100	46	42	0.5 - 16	ERC 25	050.025	052.325	053.325
160.225 050	25	50	32	42	0.5 - 16	ERC 25	050.025	052.325	053.325
160.225 070	25	70	32	42	0.5 - 16	ERC 25	050.025	052.325	053.325
160.225 100	25	100	32	42	0.5 - 16	ERC 25	050.025	052.325	053.325
160.226 050	25.40	50	32	42	0.5 - 16	ERC 25	050.025	052.325	053.325
160.226 070	25.40	70	32	42	0.5 - 16	ERC 25	050.025	052.325	053.325
160.226 100	25.40	100	32	42	0.5 - 16	ERC 25	050.025	052.325	053.325
160.226 120	25.40	120	32	42	0.5 - 16	ERC 25	050.025	052.325	053.325
160.230 070	30	70	32	42	0.5 - 16	ERC 25	050.025	052.325	053.325
160.231 070	31.75	70	32	42	0.5 - 16	ERC 25	050.025	052.325	053.325
160.232 070	32	70	32	42	0.5 - 16	ERC 25	050.025	052.325	053.325
160.232 100	32	100	32	42	0.5 - 16	ERC 25	050.025	052.325	053.325
160.244 155	44.45	155	28	42	0.5 - 16	ERC 25	050.025	052.325	053.325

ERC 25

KLEŠTINOVÉ DRŽÁKY S MATICÍ STANDARD

DIN 6499

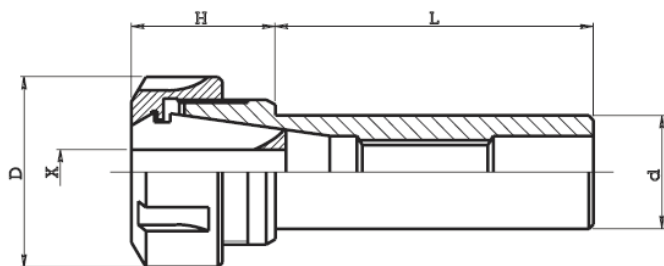

KOD	d	L	H	D	X	Kleština	Kod kleštiny	Kod matice	Kod klíče
160.319 050	19.05	50	53	50	1 - 20	ERC 32	050.032	052.332	053.332
160.320 050	20	50	53	50	1 - 20	ERC 32	050.032	052.332	053.332
160.322 050	22	50	53	50	1 - 20	ERC 32	050.032	052.332	053.332
160.325 050	25	50	53	50	1 - 20	ERC 32	050.032	052.332	053.332
160.325 070	25	70	53	50	1 - 20	ERC 32	050.032	052.332	053.332
160.325 100	25	100	53	50	1 - 20	ERC 32	050.032	052.332	053.332
160.326 050	25.40	50	53	50	1 - 20	ERC 32	050.032	052.332	053.332
160.326 070	25.40	70	53	50	1 - 20	ERC 32	050.032	052.332	053.332
160.326 100	25.40	100	53	50	1 - 20	ERC 32	050.032	052.332	053.332
160.330 050	30	50	45	50	1 - 20	ERC 32	050.032	052.332	053.332
160.330 070	30	70	45	50	1 - 20	ERC 32	050.032	052.332	053.332
160.330 140	30	140	45	50	1 - 20	ERC 32	050.032	052.332	053.332
160.331 050	31.75	50	45	50	1 - 20	ERC 32	050.032	052.332	053.332
160.331 070	31.75	70	45	50	1 - 20	ERC 32	050.032	052.332	053.332
160.332 050	32	50	45	50	1 - 20	ERC 32	050.032	052.332	053.332
160.332 070	32	70	45	50	1 - 20	ERC 32	050.032	052.332	053.332
160.332 100	32	100	45	50	1 - 20	ERC 32	050.032	052.332	053.332
160.332 140	32	140	45	50	1 - 20	ERC 32	050.032	052.332	053.332
160.335 050	35	50	27	50	1 - 20	ERC 32	050.032	052.332	053.332
160.335 070	35	70	27	50	1 - 20	ERC 32	050.032	052.332	053.332
160.338 140	38.10	140	45	50	1 - 20	ERC 32	050.032	052.332	053.332
160.340 085	40	85	45	50	1 - 20	ERC 32	050.032	052.332	053.332
160.340 155	40	155	30	50	1 - 20	ERC 32	050.032	052.332	053.332
160.344 085	44.45	85	45	50	1 - 20	ERC 32	050.032	052.332	053.332
160.344 155	44.45	155	30	50	1 - 20	ERC 32	050.032	052.332	053.332
160.350 155	50	155	30	50	1 - 20	ERC 32	050.032	052.332	053.332
160.351 155	50.80	155	30	50	1 - 20	ERC 32	050.032	052.332	053.332
160.360 155	60	155	30	50	1 - 20	ERC 32	050.032	052.332	053.332
160.363 155	63.50	155	30	50	1 - 20	ERC 32	050.032	052.332	053.332

ERC 32

KLEŠTINOVÉ DRŽÁKY S MATICÍ STANDARD

DIN 6499

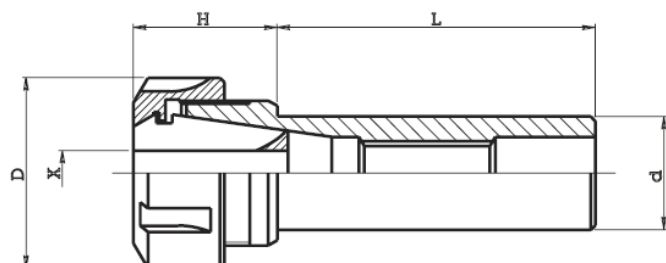

KOD	d	L	H	D	X	Kleština	Kod kleštiny	Kod matice	Kod klíče
160.425 050	25	50	60	63	2 - 30	ERC 40	050.040	052.340	053.340
160.426 050	25.40	50	60	63	2 - 30	ERC 40	050.040	052.340	053.340
160.431 050	31.75	50	60	63	2 - 30	ERC 40	050.040	052.340	053.340
160.431 070	31.75	70	60	63	2 - 30	ERC 40	050.040	052.340	053.340
160.432 070	32	70	60	63	2 - 30	ERC 40	050.040	052.340	053.340
160.438 155	38.10	155	60	63	2 - 30	ERC 40	050.040	052.340	053.340
160.440 050	40	50	60	63	2 - 30	ERC 40	050.040	052.340	053.340
160.440 080	40	80	60	63	2 - 30	ERC 40	050.040	052.340	053.340
160.440 155	40	155	60	63	2 - 30	ERC 40	050.040	052.340	053.340
160.444 155	44.45	155	45	63	2 - 30	ERC 40	050.040	052.340	053.340
160.450 170	50	170	35	63	2 - 30	ERC 40	050.040	052.340	053.340
160.451 170	50.80	170	35	63	2 - 30	ERC 40	050.040	052.340	053.340
160.460 170	60	170	35	63	2 - 30	ERC 40	050.040	052.340	053.340
160.463 170	63.50	170	35	63	2 - 30	ERC 40	050.040	052.340	053.340

ERC 40

KLEŠTINOVÉ DRŽÁKY S KUŽELEM MORSE

DIN 6499

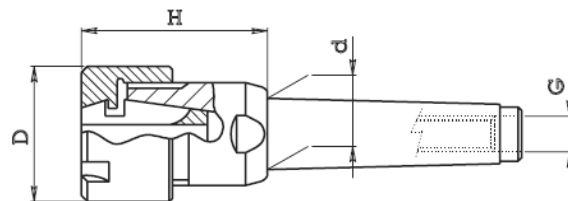
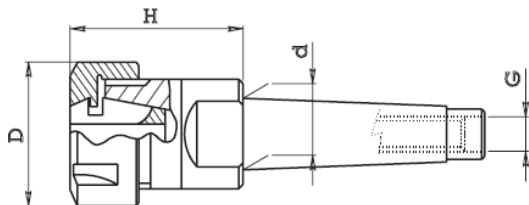

MATICE STANDARD - STANDARD NUT

KOD	MORSE	d	G	H	D	Kleština	Kod kleš.
163.701	1	12.065	M6	25	19	ERC 11	050.011
163.001	1	12.065	M6	40	28	ERC 16	050.016
163.002	2	17.780	M10	42	28	ERC 16	050.016
163.102	2	17.780	M10	50	34	ERC 20	050.020
163.202	2	17.780	M10	54	42	ERC 25	050.025
163.203	3	23.825	M12	53	42	ERC 25	050.025
163.303	3	23.825	M12	70	50	ERC 32	050.032
163.403	3	23.825	M12	80	63	ERC 40	050.040
163.304	4	31.267	M16	60	50	ERC 32	050.032
163.404	4	31.267	M16	81	63	ERC 40	050.040

MATICE MINI - MINI NUT

KOD	MORSE	d	G	H	D	Kleština	Kod kleš.
164.701	1	12.065	M6	25	16	ERC 11	050.011
164.001	1	12.065	M6	40	22	ERC 16	050.016
164.002	2	17.780	M10	42	22	ERC 16	050.016
164.102	2	17.780	M10	50	28	ERC 20	050.020
164.202	2	17.780	M10	54	35	ERC 25	050.025
164.003	3	23.825	M12	43	22	ERC 16	050.016
164.103	3	23.825	M12	47	28	ERC 20	050.020
164.203	3	23.825	M12	58	35	ERC 25	050.025

KLEŠTINOVÉ DRŽÁKY S MATICÍ MINI

DIN 6499

Poz. 1

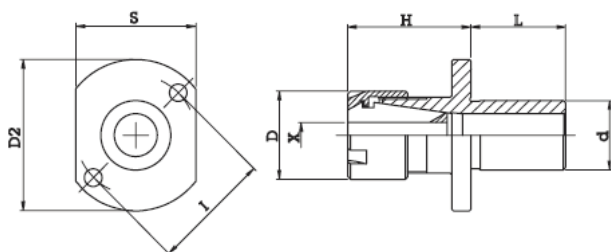

Poz. 2

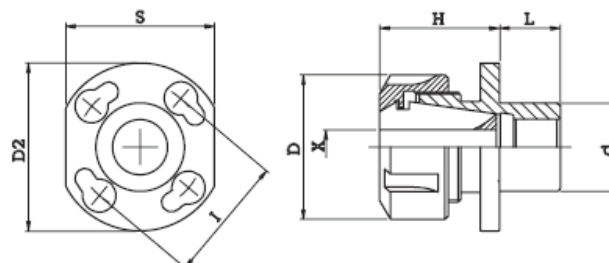

Stroj	KOD	d	L	H	D	X	D2	S	I	Kleština	Kod kleš.	Kod matice	Poz.
	165.016.021	16	21	28	22	0.5 - 10	40	24	31	ERC 16	050.016	052.116	1
STAR SR 20	165.022.025	22	25	39	22	0.5 - 10	49	28	40	ERC 16	050.016	052.116	1
STAR SR 32	165.122.025	22	25	40	28	0.5 - 13	49	28	40	ERC 20	050.020	052.120	1
STAR SR 20	165.122.030	22	30	35	28	0.5 - 13	48	38	38	ERC 20	050.020	052.120	1
STAR SR 32	165.122.030B	22	30	35	28	0.5 - 13	60	38	50	ERC 20	050.020	052.120	1
GILDEM. GM32-35-42	166.332.022	32	22	36	50	1 - 20	61	54	46	ERC 32	050.032	052.332	2

KLEŠTINY ERC

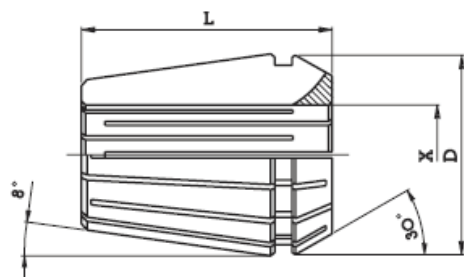

KLEŠTINY STANDARDNÍ

* SPECIALNÍ

KOD	Typ	D	L	X min	X max	Rozsah upnutí	Kusů v sadě
050.008	ERC 8	8.5	13.5	1.0	5.0	0.5	9
050.011	ERC 11	11.5	18	1.0	7.0	0.5	13
050.012	ERC 12	12	20	1.0	7.0	0.5	13
050.016	ERC 16	17	27	1.0	3.0	0.5	5
050.016	ERC 16	17	27	4.0	10.0	1.0	7
050.016*	ERC 16	17	22	11.0	12.0	1.0	2
050.020	ERC 20	21	31	1.0	3.0	0.5	5
050.020	ERC 20	21	31	4.0	13.0	1.0	10
050.020*	ERC 20	21	24	14.0	15.0	1.0	2
050.025	ERC 25	26	35	1.0	3.0	0.5	5
050.025	ERC 25	26	35	4.0	16.0	1.0	13
050.025*	ERC 25	26	26	17.0	20.0	1.0	4
050.032	ERC 32	33	40	2.5	3.0	0.5	2
050.032	ERC 32	33	40	4.0	20.0	1.0	17
050.032*	ERC 32	33	33	21.0	25.0	1.0	5
050.040	ERC 40	41	46	3.0	30.0	1.0	28
050.050	ERC 50	52	60	6.0	34.0	1.0	29

KLEŠTINY SE ZVÝŠENOU PŘESNOSTÍ

KOD	Typ	D	L	X min	X max	Rozsah upnutí	Kusů v sadě
050.008P	ERC 8	8.5	13.5	1.0	5.0	0.5	9
050.011P	ERC 11	11.5	18	1.0	7.0	0.5	13
050.012P	ERC 12	12	20	1.0	7.0	0.5	13
050.016P	ERC 16	17	27	1.0	3.0	0.5	5
050.016P	ERC 16	17	27	4.0	10.0	1.0	7
050.020P	ERC 20	21	31	1.0	3.0	0.5	5
050.020P	ERC 20	21	31	4.0	13.0	1.0	10
050.025P	ERC 25	26	35	1.0	3.0	0.5	5
050.025P	ERC 25	26	35	4.0	16.0	1.0	13
050.032P	ERC 32	33	40	2.5	3.0	0.5	2
050.032P	ERC 32	33	40	4.0	20.0	1.0	17
050.040P	ERC 40	41	46	3.0	26.0	1.0	28

MĚŘENÍ PŘESNOSTI

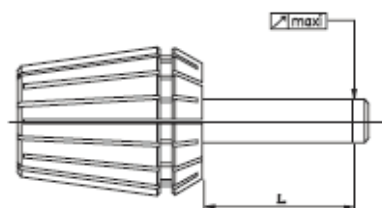

Otvor D			Maximální úchyłka (*)	
Min	Max	L	Kleštiny standard	Kleštiny vys. přesnost
1	1,6	6	0,015	0,010
1,6	3	10	0,015	0,010
3	7	16	0,015	0,010
7	10	25	0,015	0,010
10	18	40	0,020	0,015
18	26	50	0,020	0,015
26	40	60	0,020	0,015

MATICЕ PRO KLEŠTINY

MATICЕ MINI

Poz. 1

KOD	Typ	D	H	F
052.108	ERC 8	12	11	10x0.75
052.111	ERC 11	16	11	13x0.75
052.116	ERC 16	22	17	19x1
052.120	ERC 20	28	19	24x1
052.125	ERC 25	35	20	30x1

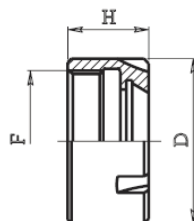

Poz. 1



MATICЕ ŠESTIHRAN

Poz. 2

KOD	Typ	D	H	F
052.211	ERC 11	19	11	14x0.75
052.216	ERC 16	28	17	22x1.5
052.220	ERC 20	34	19	25x1.5

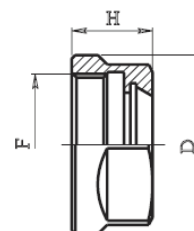

Poz. 2



MATICЕ STANDARD

Poz. 3

KOD	Typ	D	H	F
052.316	ERC 16	32	17.5	22x1.5
052.320	ERC 20	35	19	25x1.5
052.325	ERC 25	42	20	32x1.5
052.332	ERC 32	50	22	40x1.5
052.340	ERC 40	63	25	50x1.5
052.350	ERC 50	78	35	64x2

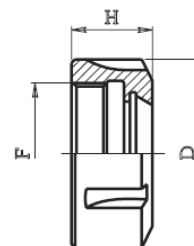

Poz. 3



MATICЕ VNĚJŠÍ ZÁVIT

Poz. 4

KOD	Typ	D	H	F
052.411	ERC 11	...	6	18x1
052.411 B*	ERC 11	...	6	18x1
052.416	ERC 16	...	8	24x1
052.420	ERC 20	...	11	28x1.5
052.425	ERC 25	...	12.5	32x1.5
052.432	ERC 32	...	14	40x1.5
052.432 B*	ERC 32	...	14	40x1.5

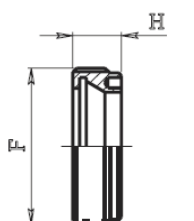

Poz. 4



KLІČE PRO MATICЕ

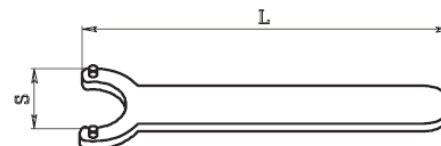
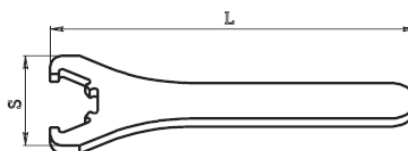
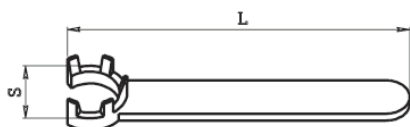

KOD	S	L	Pro kleštinu
053.108	12	80	052.108
053.111	16	96	052.111
053.116	22	118	052.116
053.120	28	130	052.120
053.125	35	132	052.125

KOD	S	L	Pro kleštinu
053.316	50	160	052.316
053.320	57	180	052.320
053.325	65	210	052.325
053.332	75	250	052.332
053.340	90	290	052.340
053.350	110	350	052.350

KOD	S	L	Pro kleštinu
053.420	20.5	160	052.420
053.425	23.5	180	052.425
053.432	32	200	052.432